

CARVER

P R O F E S S I O N A L

A Division of Phoenix Gold International, Inc.

MODEL PM-1.5

Low Feedback / High Headroom
Magnetic-Field Power Amplifier™

OWNER'S MANUAL

PLEASE NOTE:

Phoenix Gold International, Inc. purchased Carver Professional in November of 1995 from Carver Corporation. See our [Tech Support](#) page located at www.carverpro.com for specifics as to which amplifiers Phoenix Gold International, Inc. is responsible for as a servicing agency.

Table of Contents

I. Introduction.....2
II. Installation.....4
III. Features and Functions.....7
IV. Dual-Channel Operations and Connections.....18
V. Mono-Bridged Operations and Connections.....21
VI. Specifications.....23
VII. Troubleshooting/Warranty Service.....24

WARNING: To prevent fire or shock hazard, do not expose this equipment to rain or moisture.

TO AVOID ELECTRICAL SHOCK, DO NOT OPEN CHASSIS. NO USER-SERVICEABLE PARTS INSIDE. REFER ALL SERVICING TO QUALIFIED PERSONNEL.

CAUTION: When installing this equipment, read and follow all safety and operating instructions.

IMPORTANT: Carefully unpack your PM-1.5 and keep the original carton and packing materials for moving, shipment, or long-term storage.

PERSONAL WARRANTY INFORMATION

SERIAL NUMBER _____

DEALER _____

DATE OF PURCHASE _____

PERSONAL ID NUMBER/LOCATION _____

INTRODUCTION

Congratulations on purchasing a Carver PM-1.5 Low Feedback/High Headroom Power Amplifier. Your new amplifier is completely unique in design and execution, as well as unsurpassed in overall sonic performance and power output capability. The first Magnetic-Field Power Amplifiertm exclusively intended for commercial sound applications, the PM-1.5 stands in a class by itself when compared with the standards of conventional commercial power amplifiers. In any application, from the rigors and harsh demands of musical instrument amplification or live sound reinforcement to the critical sonic requirements of driving large studio monitors, the PM-1.5 can be counted on to be a superior performer in every way.

The PM-1.5 is a perfect choice for any application or system that requires an amplifier that will surmount the shattering peaks of high-contrast musical program material, characteristic of live performances, and still have plenty of headroom and power reserves to spare. When an amplifier is called on to amplify the crash of a cymbal or dynamic sound of a synthesizer, most conventional amplifiers can't provide enough power on demand to keep up with these rapid musical transients. The conventional amplifier runs out of headroom and is pushed into hard clipping. The result is dirty, obnoxious sound and the risk of damaging expensive loudspeaker systems. The PM-1.5 also has a special Clipping Eliminator to make sure it never exceeds 3% THD with up to 7 dB of overdrive, and really lowers the possibility of loudspeaker damage from the squared-off waveforms produced by any amplifier driven into hard clipping.

What makes all this, and more, possible is Bob Carver's design breakthrough in power supply configurations and engineering concepts that has become the real key to the many benefits the PM-1.5 can offer the audio professional. Years were spent in developing this proven design concept, and it has been embodied in the application of magnetic-field technology to a commercial power amplifier. Magnetic-field design is centered around a small, lightweight power supply capable of processing and storing vast amounts of energy with amazing efficiency. Instead of the massive transformers, storage capacitors, and heat sinks that contribute to conventional commercial amplifier size, weight, and cost, the PM-1.5 uses a vastly-superior method of electronic control in their place. The most obvious benefit of magnetic-field technology is the PM-1.5's remarkably compact size and weight. Conventional amplifiers capable of producing as much power can, and usually do, weigh three to four times as much as the PM-1.5, and occupy a lot of valuable rack space in an equipment rack or enclosure. By contrast, your amplifier takes up only two vertical rack spaces (3½ inches) and weighs just over 21 lbs.

When it comes to output power, the PM-1.5 can deliver over 450W rms per channel into an 8Ω loudspeaker impedance, 600W per channel into a 4Ω loudspeaker impedance, and an awesome 1200W into an 8Ω loudspeaker impedance in mono-bridged mode. It's easy to see why large, heavy conventional amplifiers with less-efficient power supplies and less available headroom must stand aside when compared to the PM-1.5.

All this power and operating efficiency is available with a absolute minimum of noise and distortion. Excellent engineering and design of the audio stages have been blended with quality components to produce the PM-1.5's impeccable specifications and superb sound quality. The ultra-linear semiconductors and circuitry used have the added benefit of reducing the need for power-consuming negative feedback. Just enough has been applied to the design to ensure linear operation and promote amplifier stability without coloring the sound or inhibiting the best performance.

The Carver Corporation understands that all this power and performance won't help if your amplifier doesn't work. To that end, the PM-1.5 employs a rugged mechanical design with heavy-duty chassis components and features--put together by people that know your amplifier must be reliable for years of active, hard use.

The PM-1.5 represents a new dimension in commercial power amplifiers, designed and built to take all the punishment and use expected in a professional product. This has been done without sacrificing or compromising the levels of sonic quality demanded by audio professionals in every area of commercial sound. However, regardless of expertise or knowledge, please read the rest of this owner's manual to take full advantage of the fantastic features and performance the PM-1.5 has to offer. Follow all operation and installation instructions exactly.

WARRANTY CARD

The PM-1.5 has been designed and crafted to take the physical and operational punishment associated with commercial sound-reinforcement application in clubs or on the road, yet operate reliably performance after performance. It's highly unlikely the PM-1.5 will ever need service if properly installed, maintained, and operated; but should the unlikely occur, the Warranty Card is a passport to Carver's one-year limited Parts/Labor Warranty Repair. Take a moment to fill out and return the Warranty Card that came in the amplifier's packing kit. You should also fill out the personal warranty information on the inner leaf of this manual. Be sure to include any personal ID number used to further identify the PM-1.5.

PACKING MATERIAL/SHIPPING CONTAINER

Even though the PM-1.5 will (and must be) installed in an equipment rack or other rack-mount enclosure, keep the carton and packing material the amplifier came in. For long-term storage or service shipment, the best container is the original carton.

BEFORE GOING ANY FARTHER...

Here are some suggested do's and don'ts that will make operating the PM-1.5 a safe and successful experience:

- * Don't operate the PM-1.5 on any ac line voltage other than 120V, 60 Hz.
- * Make all connections to and from the PM-1.5 with its Main and Sequencer power-up switches off (very important), and the power for all other components in the system switched off and/or with line cords unplugged.
- * To prevent possible shock or fire hazard, don't expose the PM-1.5 to rain or moisture. Should the amplifier get soaked, remove from service and have it dried, checked out, or cleaned before returning it to operation.
- * Should it be necessary to replace the main fuse, replace with the same type and rating ONLY (MDL 12). Using a larger fuse or fuse bypass can result in serious amplifier damage and will void the warranty. Unplug the amplifier's ac line cord before servicing the fuse.

* If the PM-1.5 will be used in mobile or portable sound systems, be sure it's securely rack-mounted in an equipment rack or enclosure with the recommended additional support using the optional support brackets or other method.

* The foam fan filter must be cleaned regularly (every 12 hours or sooner, depending on the environment). Keep all tools, fingers, or any other object out of the fan intake ports. Be sure the amplifier is completely off and/or unplugged before servicing the fan filter.

* Don't operate the PM-1.5 into nominal loudspeaker impedances less than 4Ω in dual-channel operation, 8Ω nominal loudspeaker impedances in mono-bridged mode.

* Of course, you already have been told that there are no user-serviceable parts inside the PM-1.5. Please, resist any temptation to fiddle around inside its chassis. Avoid electrical shock and/or extreme embarrassment; refer all service work to a qualified technician.

INSTALLATION

The PM-1.5 is completely rack-mountable and ready to be installed in any standard equipment rack, road/flight case, or other type of rack-mount enclosure. However, there are other considerations in rack-mounting the PM-1.5 in a mobile or portable sound system. Before getting into how and why, let's just say it's a good practice to provide additional support for rack-mounted components in a mobile system to avoid damage during an extreme handling situation. If your special installation is fixed or permanent in nature, this additional support is not required.

Mobile/Portable Rack Installation

If your sound system is portable or mobile, being set-up in clubs across town or across the country, it's an understatement to say the various components will take some hard knocks and jolts just getting to and from the job--even when they're installed in a road/flight case or rack. Other than providing an excellent means of organizing the components in a protected package that's easy to set-up and move around, road/flight cases act as an "insurance policy" to make sure the system works when it has to. However, provisions must be made for protecting the components in a road/flight case when the case is called on to do its job in an extreme handling situation.

These "extreme handling" situations can include the rough handling encountered when transporting a system by airplane, truck, or other common-carrier transportation. Even if the components are ruggedly-built and the road/flight cases are constructed of the best materials, the contents of a rack can be reduced to kit form if heavy equipment (like big, conventional amplifiers) breaks loose or stresses chassis material beyond endurance. When a rack of equipment falls from an aircraft loading bay or from a truck tailgate, tremendous forces are placed on the components on impact with the ground. These "g-forces" can be very high, causing equipment to weigh three or four times their normal weight for an instant. In that instant, the damage takes place; but even less-severe shocks can structurally damage components housed in a rack or case.

Since the PM-1.5 is so lightweight and compact, it lends itself to portable applications in systems that are shipped by air freight, or other means of transportation where the shipment of the output-power equivalent in conventional amplifiers would "break the bank" in shipping fees alone. If you plan to use the PM-1.5 in such a system, additional support must be provided at the rear or sides of the amplifier to minimize the possibility of structural damage during extreme handling. This support is over and above any attachments at the front panel. It not only holds true for the PM-1.5, but is an excellent practice for any rack-mounted equipment or component weighing more than 14 lbs.

Rack Support

If you already have a road/flight case, or are planning to order a new one to use with the PM-1.5, additional rack rails or channels must be installed, or specified to be installed, a certain distance from the enclosure's front rack rails. The purpose of this extra set of rack rails is to provide a place to secure any brackets or hardware used to support the amplifier. The location of the extra rack rails will depend on what type of hardware will be used and how it's secured to the amplifier. The PM-1.5 has two points on each side pretapped to accept 10-32 bolts. The PM-1.5 Amplifier Support Brackets (Carver PN# 000754) are secured to the sides of the amplifier at these points. If you plan to use the brackets, they must be attached to the amplifier before mounting it in the enclosure or rack. The additional rack rails should be installed, or specified to be installed 10-3/4 inches to 11 1/4 inches from the enclosure's front rack rails. Complete instructions for securing the PM-1.5 are included in the bracket's packing kit.

Of course, feel free to design and install your own custom support bracket, or consult your Carver Professional Products Dealer for more information. Just be sure you provide the proper support at the rear or sides when installing it in a rack intended for mobile use.

Installation Notes

- * The PM-1.5 should never be operated with the front or rear covers in place on the case or enclosure. This will restrict the flow of air to the amplifier's internal cooling fan. Air must be free to enter the fan intake ports on the amplifier's rear panel, and exhaust through the recessed portion of the front panel.
- * In a fixed or permanent installation where the PM-1.5 is housed in a special amp room, be sure the room has enough ventilation. Like a case or enclosure, the amplifier should not be operated in a "sealed" room.
- * Even though your amplifier is extremely efficient and is cooled by the internal fan, it will still generate some heat when called upon to produce high levels of output power. Even with the speed of the internal fan proportional to the output of the PM-1.5 and chassis temperature, it will heat up and cool down more quickly than any conventional amplifier--with or without fan cooling. A shorter thermal-time constant results from the reduced mass of the PM-1.5 (about one-third that of conventional amplifiers). This is because there's less material bulk to build internal heat. This allows the PM-1.5 to be mounted flush with other conventional amplifiers and equipment in a rack without concern about overheating it or the adjacent components. However, certain sensitive low-level components might pick up noise or hum from the PM-1.5 or other high-performance power amplifiers. If this is a problem, separate the

components and amplifiers by as much as necessary to eliminate the noise. Another option is installing a heavy shielding plate between them for the same results.

* When mounting equipment in a case or rack, it's a good practice to install the heaviest components in the bottom of the enclosure. This effectively lowers the case's "center of gravity" and promotes physical stability of the enclosure during handling and transportation.

POWER

The PM-1.5 should be connected to an ac outlet or receptacle rated at no less than 1500W. If your sound system uses several PM-1.5s or other conventional amplifiers, a multireceptacle power bar, outlet strip, or special power block should be used to ease the problem of finding enough common-point outlets to safely power the complete sound system. If you're going to use a power bar or other multireceptacle device, make sure it will handle the total maximum wattage of all the sound system components. The power bar(s) or outlet strip(s) should be plugged into an ac line circuit capable of handling the system's power requirements without tripping a circuit breaker.

If the outlets used to power the system are exposed to traffic, secure the plugs to the outlet, and the ac line to the wall/floor with "gaff" or duct tape in temporary situations. This will help avoid a possibly disastrous, accidental disconnection.

Although output power specifications are conditional to having an ac line voltage of 120V (stable), your amplifier will operate on ac line voltages from 100V to almost 140V. If the ac line voltages exceed 140V, the PM-1.5's over-voltage shutdown protector circuit will go into operation. See About Your Amplifier's Protection later in this manual.

Extension Cords

The PM-1.5's ac line cord should be long enough to reach a proper outlet in most applications. If an extension cord is necessary to supply ac power to the amplifier, use one that's three-prong grounded and 12-gauge or heavier. The longer the extension cord, the heavier the gauge for safety and minimizing line loss. Securely tape the connection between the extension cord's receptacle and the amplifier's ac line cord to prevent accidental disconnection.

ROUTINE CARE AND MAINTENANCE

Routine care of the PM-1.5 is relatively simple. Since your amplifier is intended for commercial sound applications, it may be exposed to quite a bit of dirt and grime--even when installed in a case or rack. You'll probably want to wipe the front panel and chassis (if exposed) from time-to-time with a soft, dry cloth. If you have to get something stubborn off, use a mild dish soap or detergent sparingly applied to a soft cloth; don't use alcohol, ammonia, or other strong solvents.

A necessary and very important part of routine care is the cleaning of the foam fan filter every 12 hours of amplifier operation or less. The internal cooling fan can force a great deal of air through the amplifier when the

output power and chassis temperature demands. In the course of a performance, quite a bit of dirt and smoke residue can build up; inspect the fan filter before every show or operational period between cleanings.

To clean the fan filter, simply peel it from the Velcro strips around the fan intake ports and wash it in a solution of mild soap and water. Squeeze the excess water from the filter and allow it to dry before re-installing it over the fan intake ports. Do not use ammonia or other strong solvents to clean the fan filter. If the fan filter becomes unserviceable, replacements can be obtained from your Carver Professional Products Dealer or the factory. Ask for Carver PN# 000753 when ordering replacement fan filters.

FEATURES AND FUNCTIONS

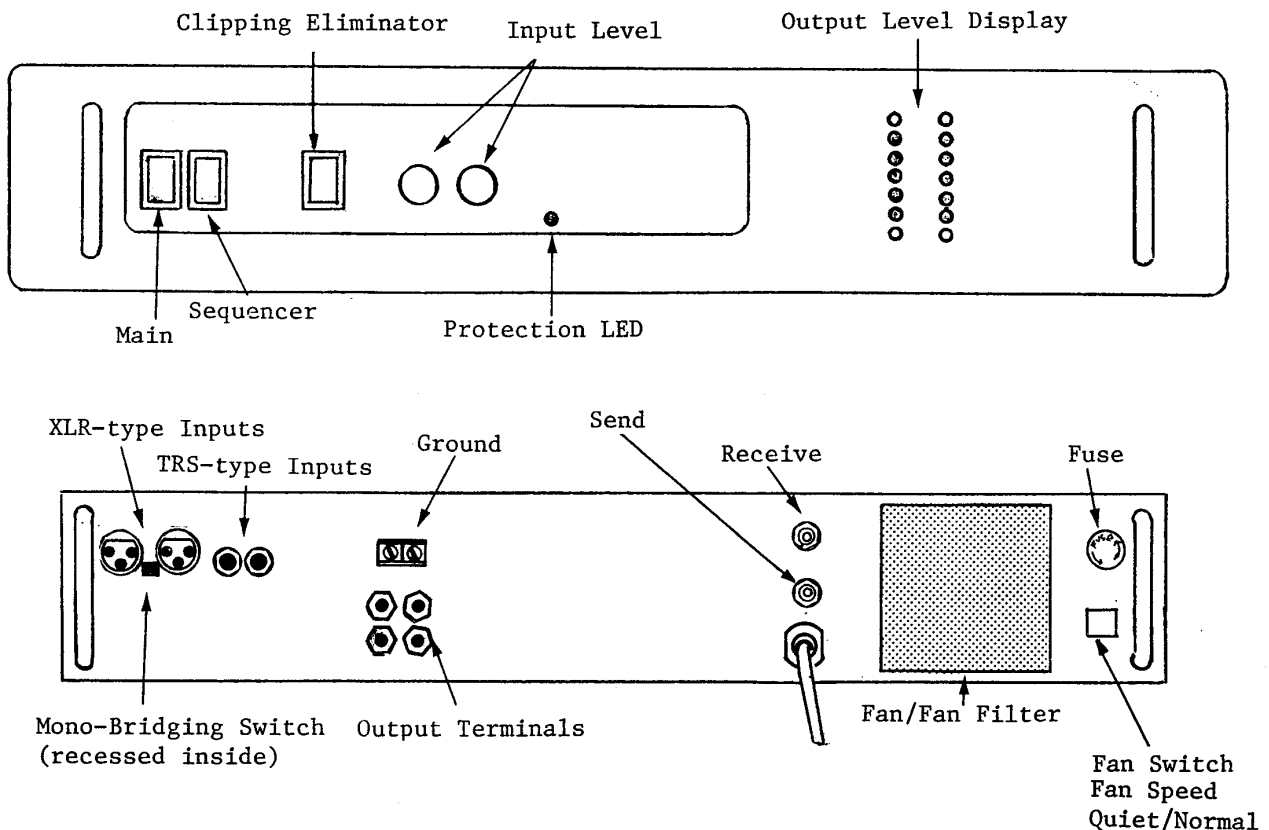

Power On/Off

A. Main

This switch, on the left hand side of the PM-1.5's recessed control panel, engages the triac control and turns the amplifier on or off when not using the remote turn-on/multi-amplifier power-up sequencing function. When using the Main switch to turn the amplifier on and off, make sure the Sequencer switch is off. Having the Sequencer on will not affect turning on the amplifier with the Main switch; it will, however, not allow the PM-1.5 to be turned off unless both switches are off. If the Main is disengaged, the amplifier will remain on with the Sequencer switched on.

B. Sequencer

This switch, to the right of the Main switch, engages the PM-1.5's special remote turn-on/multiple amplifier power-up sequencing function. This exceptional feature provides a great deal of operating convenience, safety, and security. Basically, the Sequencer can perform two functions: 1) The operator can remotely power-up a PM-1.5 from the mixing position or other location. 2) It also allows a "soft start" of a multiple amplifier array employing more than one PM-1.5. This is particularly handy for larger sound reinforcement and stage monitoring systems using many PM-1.5s. The initial turn-on of many amplifiers in a larger system could overload even a hefty ac line circuit supplying power to the amps, and could cause a circuit breaker to trip.

This feature will work with the Sequencer switch on and the Main switch off. A small dc control voltage (6-22V dc, 2-4 mA) is presented to the Receive terminal located on the rear panel. Using a single PM-1.5 as a "master amp," connected to the other PM-1.5's Send/Receive terminals, the whole rack can be started at 1.5-second intervals after the master amplifier is activated by the control voltage from another location in the room. If you don't wish to use the remote turn-on feature, the rack of PM-1.5s can be started with the master amp without using the dc control voltage set-up. The master amplifier can be activated just with its Sequencer and Main switch.

The amplifier is turned off by switching the Sequencer switch off at the amplifier. Before attempting to use this feature, read all the information in Remote Turn-On/Multiple Amplifier Power-up Sequencer later in this manual.

Ready Status

No matter which method or switch is used to power-up a PM-1.5, the two, green LEDs at the bottom of the Output Level display will illuminate to indicate the amplifier is ready for operation.

Power-Up/Power-Down Procedures

Switching the PM-1.5 on and off brings up another important topic: Preventing damage to your loudspeakers from turn-on and turn-off transients. Simply stated, the high-energy voltage spikes are caused by a component's power-supply devices charging up when switched on, discharging when switched off. This is very important when talking about a system using amplifiers as powerful as the PM-1.5. Even a smaller transient could be amplified into a shattering snap with several hundred watts behind it. The result? Damaged loudspeaker elements that could cost a lot of money to recone; worse, could cost you the night's performance--all in the twinkling of an eye.

It's obviously far better to prevent and avoid the problem in the first place. To avoid the possible problems associated with turn-on/off transients, do the following:

1. With the master gain controls on the mixing console or instrument preamp down or off, switch on all the low-level components in the system. This includes mixing consoles, on-stage instruments, effects devices, tape machines, signal processing equipment, crossovers, etc. Wait a moment for their power supplies to stabilize, then switch on or sequence start the PM-1.5(s) and other amplifiers (house main and stage monitor).

2. When powering the system down, reverse the procedure. Reduce master gain control levels at the console or preamp, then switch off the PM-1.5(s) and other amplifiers. Wait a few moments for their power supplies to discharge, then switch off the low-level equipment.

Even though your PM-1.5 generates only a small turn-on and turn-off transient (less than 2V rms turn-off transient), that can't be said about all other components or equipment. Despite relays and other transient-eliminating features on some equipment, observe the proper procedures to prevent unleashing potentially-destructive forces on your loudspeakers needlessly. The extra moment spent doing it the right way will keep your loudspeakers working with you, not spending time in the repair shop.

If power is interrupted to the sound system, it's a good idea to immediately reduce master gain controls at the board, then restart the whole system when power is fully restored. Never switch the PM-1.5 on or off during operation when signal is present at the inputs.

Input Level Controls

Input Level controls are provided for each channel to progressively reduce the amplifier's input sensitivity as they're adjusted from their full on (unity, maximum clockwise) position to off (fully counterclockwise). Each control is detented in eleven steps for precise adjustment without tracking-induced variations in level settings between channels. Other than allowing easy return to predetermined settings with minimum error, the detented controls provide accurate left/right input level settings during mono-bridged operation, if required.

How, and at what level, the Input Level controls are set will depend on how your system is set-up, and the type and features of the other components in that system. If your mixing console or instrument preamplifier is quiet, set the amp's Input Level controls full on (maximum clockwise), then use the master gain controls at the console or preamp vary the level of the drive signal. Do this if the system uses a crossover with variable output level controls for the high and low frequencies. This will help maintain the best signal-to-noise performance within the system. If the board or preamp tends to be a bit noisy, adjust the master gain control and the amplifier's Input Level controls until the noise becomes less objectionable. Use the Input Level controls to set levels if the crossover in the system doesn't have separate output-level controls for the high and low frequencies.

Clipping Eliminator

This switch engages special circuitry which detects amplifier hard clipping that continues for more than 20 msec. This circuit pulls the amplifier out of hard clipping. The Clipping Eliminator will effectively control hard clipping of the amplifier with signals up to 7dB overdrive to yield no more than 3% THD. Input signals with strength in excess of 7V rms will cause the front end of the input circuitry to clip; the Clipping Eliminator can't help that. Lower the master gain or output level controls on equipment supplying drive signals to the PM-1.5.

The threshold of the Clipping Eliminator is set to engage corresponding to 1% distortion at the PM-1.5's outputs. Conditions within the amplifier that cause this amount of distortion (less the front end) activate the circuit. Operation of the Clipping Eliminator is monitored by the two, amber LEDs at the top of the Output Level display. With the Clipping Eliminator engaged, the LEDs will illuminate when the amplifier is running out of power and the circuit is attenuating the input signal to prevent audible clipping. If the Clipping Eliminator is switched out, the LEDs indicate clipping conditions at any frequency, regardless of loudspeaker impedance or AC line voltage.

This feature can benefit the system operator by helping to protect elements in the loudspeakers from potential damage caused by amplifier hard clipping. The squared-off waveforms that result from hard clipping can destroy sensitive loudspeaker elements before you can say "oops!" It also helps maintain the overall sound quality of a system by reducing the clipping-induced distortion that's both annoying and fatiguing to the listener--a common problem with conventional amplifiers that possess far less headroom than the PM-1.5.

The Clipping Eliminator should be engaged for all normal operations.

During operation, you'll probably see the amber LEDs light from time-to-time, when the PM-1.5 is called upon to respond to the wide dynamic range and dramatic contrasts in musical program material associated with live shows or performances. The LED action is perfectly normal. If the LEDs illuminate frequently at levels that could not possibly exhaust the headroom and drive the amplifier into clipping, it's an indication of a potential internal problem. See Troubleshooting and/or remove the amplifier for service inspection.

Output Level/Protection LED Display

The PM-1.5's Output Level display consists of two, vertical LED ladders on the right of the amplifier's front panel. Another separate LED is located on the recessed portion of the front panel next to the Input Level controls. This is the Protection LED which will illuminate under gross fault conditions. (See About Protection Circuits later in this manual.)

The vertical LED ladders provide an accurate representation of the peak output level of each channel and visual indication of amplifier clipping. The display also acts as a ready status or "power on" indicator. Each vertical row consists of seven LEDs: A single green LED at the bottom, five red LEDs, and an amber LED at the top of the display. The green LED at the bottom indicates the PM-1.5 is switched on and ready for operation. The red LEDs indicate output power levels with a display attack time of 1 msec and a 500 msec decay. The top, amber LED indicates operation of the Clipping Eliminator circuit and/or distortion in excess of 1%. If the Clipping Eliminator is disengaged, the amber LED will accurately indicate amplifier clipping at any frequency, line voltage, or loudspeaker impedance. However, the portion of the display indicating output level is directly tied to both loudspeaker impedance and operating AC line voltages.

Protection LED

Located on the recessed portion of the PM-1.5's front panel, this red LED serves as an indication of fault and will illuminate when power is removed from the output devices and the amplifier is shut down by the protection circuits. When a fault condition occurs, illuminating the Protection LED, the Output Level display will "strobe" in synchronization with a low-level "pup...pup" sound coming from the loudspeakers connected to the amplifier in question. Consult the section About Protection Circuits later in the manual.

The LED/audio alert system is designed to provide positive indication of a fault. When the fault condition is removed or corrected, the Protection LED will go out, the display won't strobe, and the audio alert will cease. The green LEDs at the bottom of the Output Level display will illuminate to indicate the PM-1.5 is ready to go again.

Inputs

Signals to drive the PM-1.5 are supplied from either a dual differentially-balanced pair of female XLR-type connectors or a pair of TRS ¼-inch phone jacks. Both styles of connector have the same input impedance: 15 k Ω each leg balanced to ground for a total input impedance of 30 k Ω . The input overload point for the line amplifier is 7 volts rms. This insures full compatibility with all modern signal sources, for both input overload and an optimum input signal-to-noise ratio.

The balanced XLR-type and TRS inputs have been designed to allow single-ended (unbalanced) input operation without switches or adaptors. The only thing required here is a set of properly wired signal cables. See Cables and Cords in this manual.

The input connectors on the PM-1.5 are wired in parallel to allow signals to be passed on when "cascading" multiple amplifier arrays.

Mono-Bridging Switch

A switch recessed between and below the pair of XLR-type input connectors is used when operating the PM-1.5 as a mono (single-channel) amplifier. Before operating the PM-1.5 in mono-bridged mode, the switch must be pushed in to phase-invert the left-channel drive signal. The switch must be pushed in with a narrow screwdriver. Push it in gently with the tool. Never activate this switch with the amplifier plugged in and/or operating. Be sure the switch is out when resuming dual-channel operation.

NOTE: Before attempting to operate the PM-1.5 in mono-bridged mode, please read the section on Mono-Bridged Operation later in this manual.

Ground

A small barrier strip located above the output terminals provides a means of altering the grounding scheme of the PM-1.5's inputs. As it comes from the factory, a jumper bar connects the input grounds to the amplifier's chassis. For normal use, the jumper should remain in place. The jumper may be removed for certain types of installations and applications, or may be helpful in solving certain ground-loop hum and noise troubles. Removing the jumper leaves a 0.1 μ f capacitor in parallel with a 27 k Ω resistor between the amp ground and the chassis.

Output Terminals

The PM-1.5's Output Terminals are both flexible and straightforward. Two vertical pairs of five-way binding posts supply output to the loudspeakers for both dual-channel and mono-bridged operation.

Connections to the loudspeakers may be made in several different termination styles. The Output Terminals accept both single- and dual-banana plugs, spade lugs, and stripped or tinned leads. The type of connection you make will depend, again, on the application of the system the PM-1.5 is a part of. For example, dual-banana plugs are a safe, convenient method of terminating speaker wires at the amplifier and loudspeakers. Other than the locator tab (along one edge of the connector) being perfect for assuring polarity--even in the dark, cramped space behind an equipment rack--this style connector provides a margin of safety during an accidental trip-and-stumble routine with a speaker wire.

The banana plugs just pull out of the terminals; the equipment doesn't get pulled to the floor. If your sound system gets set-up and taken apart on a regular basis, a tinned speaker-wire lead or spade-lug terminal would undoubtedly fail from flexing and bending--leaving no connections to the loudspeakers and no sound. However, tinned leads or spade lugs provide excellent terminations for fixed and permanent installations that put a minimum of wear and tear on the output-terminal connections.

See Cable and Cords, Dual-Channel/Mono-Bridge Operations later in this manual before attempting any connections between your PM-1.5 and loudspeakers.

Remote Turn-On/Multiple Amplifier Power-Up Sequencing

These two binding posts provide operational connections at the amplifier for receiving the 6-22V dc, 2-4 mA control voltage needed to remotely turn-on or "soft start" a whole rack of PM-1.5s. The upper terminal (green, Receive) is used for connecting the hot (+) side of the dc control voltage (ground or "-" to chassis), or the dc control voltage pulse from a master amplifier in the amp rack. The lower terminal (orange, Send) supplies the sequential dc control pulse to the next PM-1.5 in the power-up sequence, soft starting them at 1.5-second intervals. See Remote Turn-On/Sequencing later in this manual for connection and operating procedures.

Fuse

Replace with the same type and rating ONLY (MDL 12 or 12A, slo-blo equivalent). The PM-1.5's fuse type and value have been selected to allow full dynamic range, and allow the amplifier to track the most powerful musical waveforms without compromising the safety of the transformer and triac control circuitry. Never replace the fuse with a different type or rating: Never, never use a fuse bypass or "cheater." Doing either of these things can result in serious amplifier damage and will void the warranty. Make sure the ac line cord is unplugged before attempting to service the fuse. If the fuse blows more than once after the initial replacement, remove the amplifier for immediate service inspection.

Fan/Fan Filter

Your PM-1.5 employs a practical and unique method of forced-air cooling. The PM-1.5 draws air in through rear panel intake ports and exhausts out through the front panel (recessed portion).

Instead of a noisy constant-speed fan cooling system, the PM-1.5 uses a proportional system where fan speed (hence, cooling capability) is tied directly to the demands placed on the amplifier's power supply, as well as the chassis temperature. At idle (no signal present at the inputs), the fan operates quietly at a very slow speed. As drive signal is applied to the amplifier, the fan speed increases as the power output of the amplifier increases, and decreases as the output decreases. If operating conditions or the environment create internal chassis temperatures over 50° C, the fan will run at a high speed that's still proportional to the

amplifier's output power demands, until the chassis temperature falls below 50° C.

Note the Quiet/Normal switch to the right of the fan. You will want the switch in the Quiet (out) position for use in environments with extremely low ambient noise. In most applications you will want the switch pushed IN to the NORMAL position.

Should, for any reason, the chassis temperature go over 90° C, the amplifier will completely shut down until it has cooled. Check to make sure the fan intake ports and front-panel vent are unobstructed and the foam fan filter is clean. If your system is used outdoors, shield the amplifiers from direct sunlight with a tent of aluminum foil or provide another form of shade; this should be done even if the amplifier is mounted in an enclosed rack.

More About Your Amplifier's Protection Systems

To further enhance your PM-1.5's operational reliability, safety, and dependability, a number of protective circuits have been built-in to guard against major faults that could damage the amplifier. Over and above the Clipping Eliminator, which prevents the various problems resulting from hard clipping an amplifier, other protective circuits are designed to effect immediate turn-off of the amplifier. This is done automatically and will last until the fault condition is corrected or removed. Some major faults/conditions that can activate the PM-1.5's shutdown protection circuits include:

1. Over Voltage: If the AC line voltage exceeds 140V, or if internal components create a condition where DC voltages within the amplifier exceed 130 - 140V DC.
2. Excessive High-Frequencies: Excessive high-frequency signals (nonmusical) present at the outputs.
3. Excessive Low-Frequencies: Excessive out-of-phase, infrasonic/low-frequency oscillation present at the outputs.
4. DC Offset: Significant DC offset (2 - 4V DC) present at the outputs (internal or external cause).
5. Internal, Low-Level Supply Fault: Internal component problem causing imbalance in the amplifier's low-level power supplies.
6. Amplifier Overheated: Activated when the chassis temperature exceeds 90° C.

Depending on the fault condition or problem that activates the PM-1.5's protection circuits, the amplifier will give a visually positive indication and/or simply shut itself off in response. For example, in shutdown protection conditions 1 through 5, the Protection LED will illuminate, the Output Level display will strobe, and the audio alert will sound softly through the loudspeakers connected to that amplifier. In condition 6, the amplifier will shut down completely until cool. In conditions 2 and 3, the protection

circuits have been designed to react only to signals and oscillations that are different to any conceivable music signal. As a rule, feedback troubles and auxiliary component problems will be the cause that activates these circuits. If the PM-1.5's protection circuits go into action, they will remain working as long as the problem exists or until it's removed. Another advantage to the PM-1.5 shutdown protection circuitry is its "totally on or totally off" mode of operation only when a clear need arises for it to work. This is in direct comparison to conventional amplifiers' protection circuits that often interfere with, or compromise, the sound quality when conditions are near their operating thresholds.

NOTE: When the shutdown protectors are activated or the amplifier is shut down, the Protection LED will illuminate (however briefly). The amplifier will not be able to restart until the Protection LED illumination has completely decayed. This prevents the PM-1.5 from ever rapidly being switched on and off; this eliminates the possibility of it generating a massive, loudspeaker-killing transient from that needless, improper activity.

Cables and Cords

One of the most important aspects of setting-up a sound system--virtually any sound system--is the condition, type, and quality of the cords and cables used to interconnect the various components within the system. Cables and cords appear in all places and parts of a sound system, and may be the "weakest link" in the audio signal chain. Why?

Consider that cables and cords are subjected to the most physical abuse during set-ups, the performance, and when the system is broken down at the end of a show. The microphone cables and cables running from the stage box termination of a multipaired snake cable are probably subject to the most strain and wear from repeated connections, disconnections, being stepped on, etc. As a result, these cables are prone to failure: If they fail, the sound system won't work if the cords are in a critical (and what isn't) part of the signal chain. Of course, we're concerned with the cords and cables used to supply drive signal to the PM-1.5 and those within the amplifier rack. Pay close attention to the following information. Part of the complete operational success is preventing system failure from faulty interconnect cables. Other than the important low-level signal cables, there are the speaker wires that connect the PM-1.5 to the loudspeakers for consideration.

Drive signals are supplied to the PM-1.5 via dual differentially-balanced XLR-type (female) and $\frac{1}{4}$ -inch TRS input jacks. The connections may be made in either balanced or unbalanced mode, depending on your requirements, applications, and output capabilities of the components driving the PM-1.5. It may be that your mixing console, instrument preamp, or signal processing components have both balanced and unbalanced outputs, or exclusively one or the other. The decision to operate a sound system in either mode will depend a great deal on where and how the system is installed and operated. Running a balanced system has many advantages in reducing noise and rejecting interference, particularly when it comes to long runs of snake cable or interconnect lines from the console/crossover components. On the other hand, an unbalanced system is fine for instrument kits and other applications where maximum noise suppression is less of a concern or consideration. Of course, there's the obvious aspect of component flexibility: If your preamp or adjoining component only comes with unbalanced outputs, then your choice can

be somewhat limited. The thing to remember is that if you plan to operate a balanced system, make sure everything is balanced--in short, balanced outputs from the console going to the balanced inputs on an equalizer, or crossover going to the balanced inputs on the PM-1.5. If other amplifiers are being supplied signal via the paralleled input connectors on the PM-1.5, the connections between them must be to their balanced inputs, etc. The same holds true for running the system in an unbalanced mode: Keep your connections one way or the other. If you run part of the system balanced and the rest unbalanced, it can cause severe noise and hum problems--even damage the output circuitry on some balanced-drive, low-level components.

Balanced Cables/Connectors

Selecting which rear-panel connectors to use to supply drive signals will depend on the type of connectors used as terminations on the stage box of a multipaired snake cable or the output connectors on the component supplying signal. The PM-1.5's input connector group provides a great deal of flexibility in this area. Signal may be supplied via the XLR-type, 1/4-inch TRS jacks, or both. The pin configurations for the PM-1.5's input connectors are as follows:

1. Female XLR-Type Inputs: The connectors are wired so that Pin 1 is ground, Pin 2 is "-" (Low), Pin 3 is "+" (High).

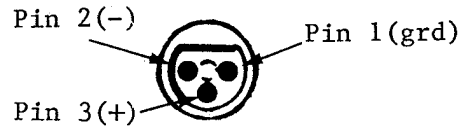

2. 1/4-Inch TRS (Tip, Ring, Sleeve): These jacks are wired so that the Tip is "+" (High), Ring is wired "-" (Low), and the plug sleeve is ground.

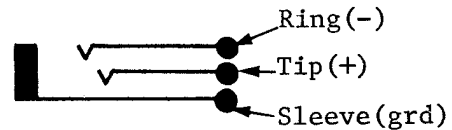

Balanced cord configurations should always be made in-phase, or so that Pin 1 on the PM-1.5's female XLR-type input corresponds to Pin 1 on a male XLR-type connector at the output of the component supplying drive signal, etc. The same hold true for using a 1/4-inch TRS jack (at a stage box) being run to the XLR-type inputs on the amplifier; where the Sleeve of the TRS jack is connected to Pin 1 on the amp, etc. Consult the operating guides and/or inspect the wiring arrangement on components supplying drive signal for the PM-1.5 for their pin out arrangement.

Since the PM-1.5's input connectors are wired together in parallel, the "unused" connectors can supply signals when cascading several amplifiers with the same drive signal. Patch cords should be wired in-phase, and should be balanced in configuration if everything else is run in balanced mode. Either TRS or XLR-type may be used in this manner.

Unbalanced Cables/Connectors

1. Female XLR-Type Inputs: The connectors on the PM-1.5 are wired so that cables supplying unbalanced drive signals are wired so the "+" is connected to Pin 3 and the ground to Pins 1 and 2.

Pin 1/Pin 2 connected(-/grd)

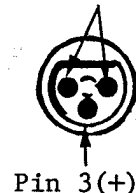

Note: Failure to connect Pins 1 and 2 will result in an approximate 50% reduction in gain. This is done automatically when using the TRS jacks to supply unbalanced drive signal to the PM-1.5 with standard ¼-inch phone plugs.

2. ¼-Inch TRS (Tip, Ring, Sleeve): The TRS jacks are wired so that cables supplying drive signal in the unbalanced mode are wired so the tip of a standard ¼-inch phone plug is "+" and the barrel portion is ground.

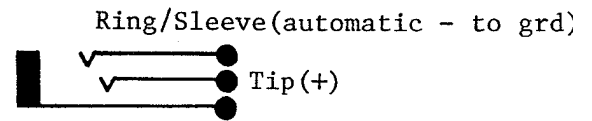

Signals to cascaded amplifiers are still supplied as they are in balanced mode. In this case, the main drive signal should ideally be supplied to the XLR-type connectors on the PM-1.5. The signals to the other amplifiers can be made from the ¼-inch TRS jacks using cables terminated in standard ¼-inch phone plugs.

As we mentioned earlier, cables and cords can be a source of potential trouble for any operator of any sound system. We strongly recommend that you obtain a cable tester to check the interconnect cables and cords in a system before each use. These cable testers check for conditions that will cause a failure, but probably aren't visible. The cable tester checks for shorts, phasing problems, and broken shielding between conductors. The cable or cord to be tested is plugged into the appropriate connectors on the tester, then the cable can be flexed, stretched, or whatever. LEDs on the tester give a positive indication of a cable that's okay, or one that has a problem--even a subtle problem that never seems to become obvious until halfway through the night's performance.

If you plan to do-it-yourself and build the cables needed to interconnect the PM-1.5 in the system, please, know how to solder. Cold or improper solder joints will be a source of headaches and trouble. Also, use the best materials to ensure long life of the cable and fewer related problems. An excellent alternative is obtaining the necessary cables from your Carver Professional Products Dealer. Many companies manufacture high-quality, reliable cables and speaker wires in many different configurations, connector styles, and lengths. Some of these premade cables even come with a performance guarantee--the peace of mind and operating security can more than justify the cost of such a cable.

Another thing to remember is to inspect and/or replace any cable going from or to a component "suspect" of causing a system failure. It's a sad fact, but the vast majority of problems in a sound system relate directly to the cords and cables used to hook-up the components. Look at the cables, test them, even replace them before jumping to the conclusion that something is "wrong" with the PM-1.5 or other component.

Speaker Wire

As important as using good quality, properly wired cables to supply drive signals to your PM-1.5, it's equally important to use a quality speaker wire to connect the output terminals to the loudspeakers. There are different types of speaker wire intended for use in commercial sound systems, but there are two common choices: "zip" or lamp cord and rubber-covered, two-conductor cables. Both types are readily available and fairly inexpensive, and use a coding system for phase identification of the conductors. Lamp cord has a small ridge or marking on the insulating jacket of one conductor; some use silver- and copper-colored wires to note the difference between the conductors. Rubber-covered,

two-conductor speaker wires use a color code on the insulating jackets of each conductor (white/black, red/black, etc.).

While speaker wires as light as 16-gauge can be used to connect the amplifier to the loudspeakers, heavier-gauged speaker wires should be used in any wire run over a few feet. Heavier speaker wires minimize line losses and will improve the damping factor. The speaker wires can be terminated at the amplifier by hard-wiring to the binding posts, spade-lug terminals attached to the conductors, or with dual-banana plugs. The banana plug is a good choice for most applications. These connectors, as we mention earlier, have a locator tab along one side that's normally clocked so it denotes the negative ("-") side of the terminals and speaker wire. Like the low-level signal cables, speaker wires may be purchased with the proper terminations and wire gauge for your amplifier and loudspeakers. If you aren't sure how to put a good speaker wire together, consult your Carver Professional Products Dealer. They will undoubtedly carry a speaker wire that will suit your needs and requirements.

A final warning to people that plan to use the PM-1.5 in an instrument system: Don't use a guitar cord to connect the PM-1.5 to your loudspeaker cabinet. The conductors in a guitar cord are flimsy and too light for the job--even in a pinch. Use the proper speaker wire in any application.

Dual-Channel Operations and Connections

The PM-1.5 can be operated with both channels amplifying a stereo pair of drive signals or two mono signals independently in dual-channel mode: For example, a signal from the stereo outputs of a mixing console for main or studio monitor loudspeakers, as opposed to a separate signal to drive a set of house main loudspeakers with one channel, and stage monitors with the other. Of course, there are biamplified/multi-amplified loudspeaker systems that will take advantage of the dual-channel mode of operation when driving separate low-frequency/upper-frequency elements. If your system application requires a dual-channel mode of operation, perform the connections as follows.

With the power for the PM-1.5 and other components in the system completely off, connect the cables that run from the outputs of the mixing console, instrument preamp, crossover, etc. to the appropriate left/right channel inputs on the PM-1.5. Consult the diagram.

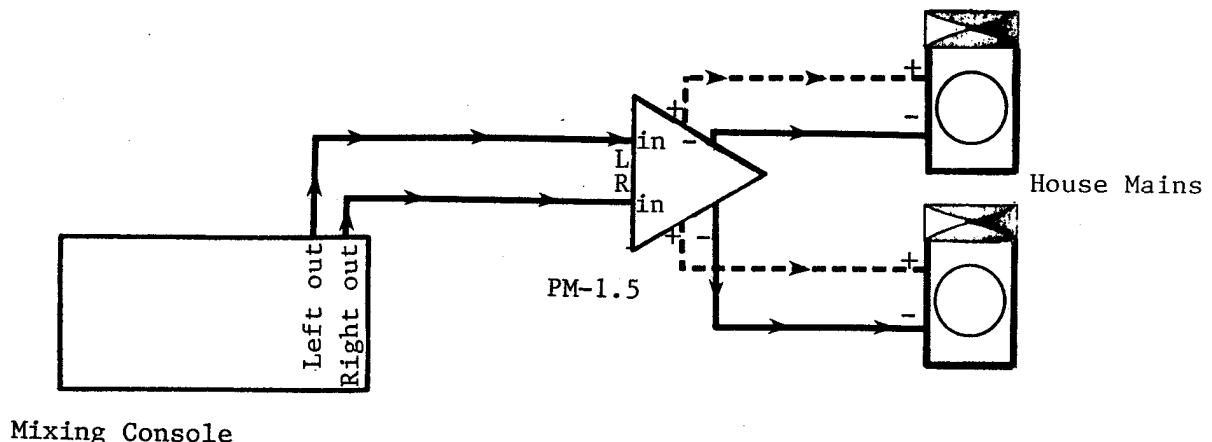

In this sample system, the left-main output of the mixing console is connected to the left-channel input of the PM-1.5. The right-main output of the mixing console is connected to the right-channel input of the amplifier. Be sure the connectors are seated firmly in their respective jacks. Connect the speaker wires between the output terminals on the amplifier and the loudspeakers to maintain proper loudspeaker phasing. The PM-1.5 should be connected to loudspeakers with a nominal impedance of 4Ω or greater ONLY in dual-channel operation. A variation on this basic-system theme is using both channels on the PM-1.5 to independently drive separate loudspeaker systems, or separate elements in a loudspeaker system. The following diagrams show these set-ups:

Other Dual-Channel Systems and Applications

This sample system uses a PM-1.5 to drive both the house-main loudspeaker system and a stage-monitor loudspeaker system. Here the connections are made from the mixing console's main output to the left-channel input on the PM-1.5. Signal to drive the monitor loudspeaker system is taken from the monitor master output on the console and is connected to the right-channel input of the amplifier.

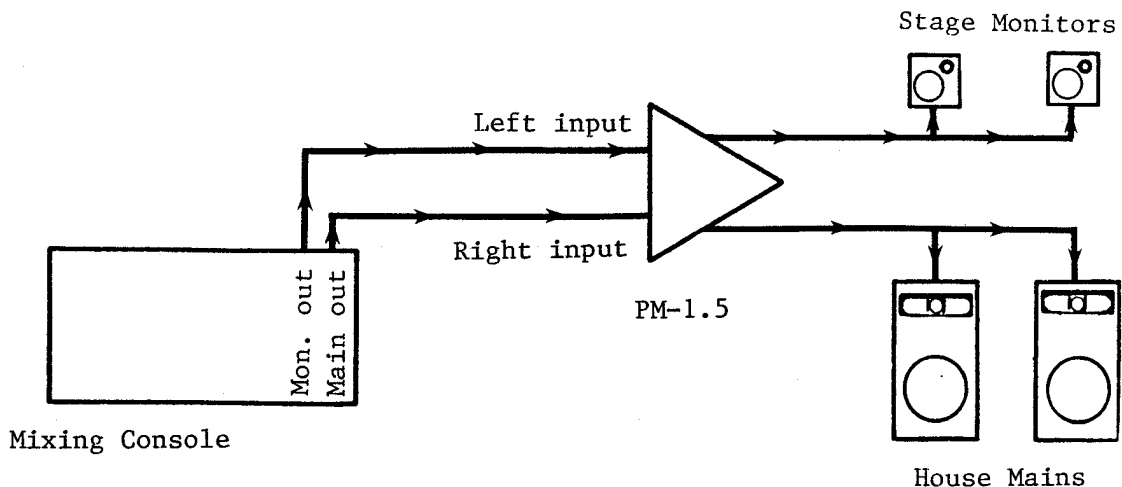

If your sound system uses biamplified or multi-amplified loudspeakers, connections are from the high-/low-frequency outputs of the crossover to the amplifier's inputs.

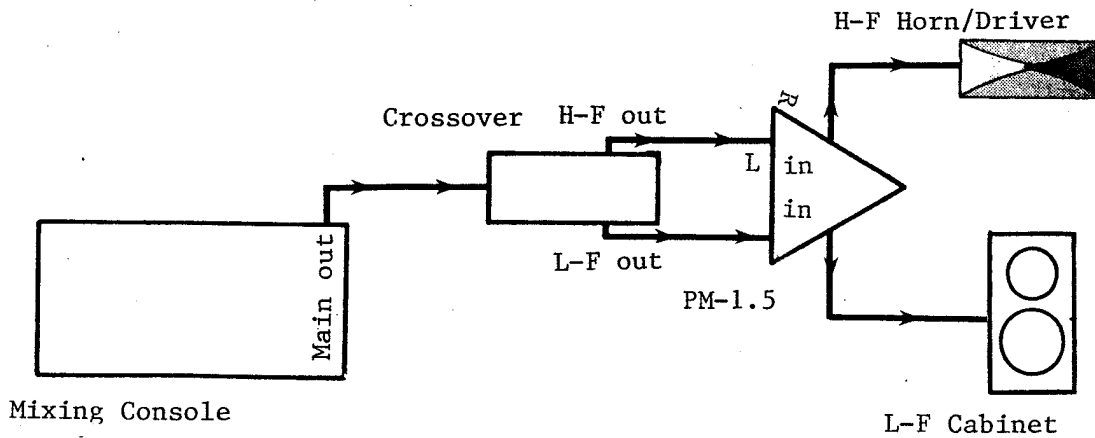

The diagram shows the connections for such a system. Here, the high-frequency output of the crossover is connected to the left-channel input of the PM-1.5, and the low-frequency output of the crossover is connected to the right-channel input. Connections are made between the respective loudspeaker elements and the amplifier's output terminals. Of course, the loudspeakers in this set-up, like any dual-channel set-up, must have a nominal impedance of 4Ω or greater.

Applications Note: If your loudspeakers are biamplified or multi-amplified, it's important to remember the powerful output capabilities of the PM-1.5. Traditionally, high-frequency compression drivers have a maximum power-handling capacity of less than 100W. Even though the PM-1.5 employs a host of protection circuitry for the amplifier and loudspeakers, there's nothing to prevent over-powering fragile drivers with a 600W driving force caused by accidental ac line noise, faulty signal cables, feedback, or whatever. Use extreme operating care and caution if you plan to power high-frequency drivers with the PM-1.5. Always preset the PM-1.5's Input Level controls and/or the crossover's output level controls to some safe minimum. Also, make sure the drivers are fused and protected according to the instructions issued by their manufacturer. Naturally, Carver Corporation cannot be responsible for damage to loudspeakers or loudspeaker elements connected to this amplifier.

Another side to this is exercising caution when using the PM-1.5 to drive full-range loudspeaker systems (those employing passive, high-level crossover networks). Just like individual loudspeaker elements can be over-driven by applying more power than they can handle, a passive, high-level crossover can be over-driven with the same results--failure. These crossovers usually consist of a series of coils, capacitors, and resistors instead of the active electronics of a low-level crossover to provide frequency-separated outputs to the individual loudspeaker elements. A passive, high-level crossover does its frequency dividing after the power amplifier. By contrast, an active, electronic crossover provides a line-level (low) signal sent to amplifiers which are connected to the appropriate loudspeaker elements. There are some distinct advantages to a bi-amplified or multi-amplified loudspeaker system, as opposed to the full-range cabinets using a passive, high-level crossover. Unfortunately, that's a long story. Let's just say that there are certain considerations that must be made when using a full-range loudspeaker system with the PM-1.5.

These passive, high-level crossovers have a maximum power-handling capacity, just like a loudspeaker. If the power rating of this type of crossover is exceeded by more than a little bit from time-to-time, the crossover

network becomes "saturated" and changes the intended crossover slope (from 12 dB/octave to 8 or 6 dB/octave) to feed more low-frequency program material to the high-frequency elements than they can handle. The result is driver failure--worst case can result in crossover network failure. Either problem can be expensive. Make sure any high-level crossover is rated to take the long-term and/or peak-voltage power output of the PM-1.5. In short, make sure your full-range loudspeaker cabinets have a BIG internal crossover. If you aren't sure about the power handling capacity of a passive, high-level crossover, consult the owner's manual that came with them or your professional audio dealer/specialist. These statements are true of any loudspeaker/crossover arrangements used with the PM-1.5 in dual-channel or mono-bridged modes of operation.

Mono-Bridged Operations and Connections

The PM-1.5 may be used as an immensely powerful single-channel amplifier by setting-up and connecting it as follows. Be very certain the power to the PM-1.5 is off and/or the line cord unplugged.

1. Mono-Bridge Switch: The Mono-Bridge switch (recessed between and below the XLR-type input connectors) must first be pushed in. Use a narrow screwdriver or other thin device (insulated) to activate the switch by gently pushing it in. This switch inverts the phase of the left-channel input signal, necessary to operate this amplifier in mono-bridged mode. Do not activate this switch with the amplifier operating. Also, check to see that it is out if you plan to go back to using the PM-1.5 in dual-channel mode.
2. Signal Connections: In balanced or unbalanced modes, signal must be equally supplied to both left- and right-channel inputs. This may be done by using a patch cord between the two TRS $\frac{1}{4}$ -input jacks while the main drive signal is supplied through one of the XLR-type connectors. It doesn't matter which one since the input connectors are wired in parallel. It's probably best to come into the right channel XLR-type input connector. This frees the left channel to feed signal to other amplifiers when cascading them. Another option is using a "Y" cord to feed drive signals to the left/right inputs on the amplifier.
3. Loudspeaker Connections: The PM-1.5 must be used with loudspeaker impedances 8Ω or greater when operating in mono-bridged mode (nominal). The connections at the output terminals are a little different than in dual-channel mode. In dual-channel mode, the loudspeakers are connected so that the "+" terminal is the upper terminal in each output pair and the lower is the "-" terminal. This arrangement changes in mono-bridged mode. Instead of two outputs, there's only one. Here the upper terminals of both output pairs are connected to the loudspeaker(s). The upper-right terminal becomes the "-", and the upper-left terminal becomes the "+." If you are using dual-banana plugs for terminating the speaker wire, clock the locator tab (on the "-" side) so it's to the upper-right terminal for proper phasing of the output connections.
4. Input Level Settings: The Input Level controls must be set to the same level in mono-bridged operation. This is made a lot easier by the eleven-position detented controls. Set and note the level settings if required. The output level control on a crossover can vary the strength of the input signal, but then be sure to have the PM-1.5's left/right Input Level controls either wide open (maximum clockwise) or appropriately adjusted the same.

Remote Turn-On/Multiple Power-Up Sequencing connections and Operation

The PM-1.5 comes ready to use a special feature that can allow the system operator to remotely turn-on and/or sequentially power-up a single PM-1.5 or a whole rack full of them. Obviously, the remote turn-on aspect provides a full measure of convenience and system security, while the multiple amplifier power-up sequencing prevents ac line voltage sags or circuit breaker kick-outs when powering-up a system with many amplifiers. In the latter case, ac line problems are eased by having the PM-1.5s turn-on at 1.5-second intervals after a "master" PM-1.5. This is done with a small dc control voltage to activate this feature. Connection and operation are as follows:

1. DC Control Voltage: The remote turn-on/sequencing feature requires a dc control voltage of 6-22V dc, 2-4 mA. A 9V transistor radio battery is an inexpensive choice for a dc power source. Connect the hot side ("+") of the dc voltage source to the upper, green-colored binding post (marked Receive) and ground it to the chassis side of the rear-panel barrier strip. This is required for both remote turn-on and sequencing.

The switch or "key" that completes the circuit to remotely turn-on/sequence the PM-1.5 can be located wherever it's convenient for the operator. System security can be enhanced by adding a key-activated switch that can prevent unauthorized system use (if the amplifiers are "locked down"). Any switches used to activate the dc control voltage supply circuit can be momentary contact-types; the PM-1.5 must see the control voltage for at least five seconds before switching on and/or beginning the sequencing of a rack full of PM-1.5s.

2. Connections at the Amplifier(s): If the dc control voltage has been connected as described in the preceding section, the PM-1.5 is ready to be remotely turned on. With the front panel Main switch off and the Sequencer switched on, the PM-1.5 will turn-on when the dc control voltage is applied for at least five seconds. There's no harm in leaving the control voltage on but it may drain any battery used for this purpose.

3. Sequential Power-Up: Control voltages and connections are made to a single PM-1.5 as described in the preceding section. In order to power-up other PM-1.5s sequentially, it becomes what we'll call the "master" amplifier. Connections to the other, or "slave" amplifiers, are very simple. After the control voltage connections are made to the Receive terminal and chassis, connect a single wire (22- to 18-gauge will do just fine) from the terminal marked "Send" on the master PM-1.5 to the Receive terminal of the next PM-1.5 to be started after the master amplifier. Engage the slave amplifier's Sequencer switch with the Main switch off. Connect another wire from the first slave amplifier's Send terminal to the Receive terminal of the second slave PM-1.5, and so on--for as many PM-1.5s as you have in the system. When the master PM-1.5 is switched on with the control voltage applied for five seconds, the slave amplifiers will turn-on at 1.5-second intervals to soft start the whole rack.

If you choose not to use the remote turn-on part of this feature, but still want to sequence-start a rack of PM-1.5s, make the connections between the master amplifier and slave amplifiers as described in the preceding paragraph. Without the dc voltage source and switch, the rack of amplifiers can be started by using the master amplifier's Main switch and Sequencer switches. Push the Sequencer switch in first, then the Main switch when you

want to power-up the system. Remember to switch both switches on the master amplifier off when powering the system down.

Of course, you must observe the proper power-up/down procedures detailed earlier in this manual: low-level electronics switched on first, then switch on the amplifiers when powering-up, amps first then low-level electronics when powering-down. In an emergency switch off both the Main and Sequencer switches.

PM-1.5 Specifications

Power: 8Ω , 450W per channel (20 Hz-20 kHz with both channels driven and no more than 0.1% THD.)

4Ω , 600W per channel (20 Hz-20 kHz with both channels driven and no more than 0.1% THD.)

16Ω , 300W per channel (20 Hz-20 kHz with both channels driven and no more than 0.1% THD.)

IM Distortion: Less than 0.1% SMPTE.

Frequency Response: -3 dB at 3 Hz, -3 dB at 80 kHz.

Damping: 200 at 1 kHz.

Gain: 26 dB.

Noise: Better than 115 dB below 450W (A-weighted).

Inputs: XLR-type or TRS $\frac{1}{4}$ -inch phone.

Input Impedance: $15\text{ k}\Omega$ each leg, balanced to ground.

Slew Rate: 25V per microsecond.

Mono-Bridging: 1200W into 8Ω , 1000W into 16Ω , accessed through rear-panel recessed switch.

Dimensions: 19"/3-1/2"/10-13/16" (W/H/D)..

Weight: 21 lbs.

AC Power: 120V, 60 Hz, 6A (1500W).

Accessories: Amplifier Support Brackets (Carver PN#000754)

The Carver Corporation reserves the right to improve its products at any time. Therefore, features, specifications, and prices subject to change without notice.

Troubleshooting

If you're having trouble or suspect a problem with the PM-1.5, try some simple troubleshooting first. More likely than not, the problem lies elsewhere in the system--not with your amplifier.

1. If one channel is "dead" (no sound), check the input cables to that channel. Inspect all connections to make sure they are firmly seated in their respective jacks--at the amplifier and at the component(s) driving it. This means from the amplifier inputs to the outputs of the mixing-console or instrument preamp. Check the output terminals for disconnection there and at the loudspeakers. Inspect loudspeaker fuses.
2. If the shutdown protector circuits have been activated, attempt to isolate and correct the cause or fault. Inspect speaker wires for "frays" and shorts. Make sure the amplifier's internal cooling fan is getting enough freely circulating air (if overheated/overtemp. problem is indicated). If no cause or fault can be found, remove the amplifier for service inspection.
3. If the main fuse blows, try to determine the cause. If the fuse blows again, remove the amplifier for service inspection if no external cause can be found.

Again, the majority of troubles and problems with a sound system revolve around faulty interconnect cables and cords. We advise double-checking each cable and cord with a good cable tester. Replace any suspect cables before going any farther with the troubleshooting procedure.

If all methods of finding the problem don't work out, contact:

CARVER CORPORATION CUSTOMER SERVICE
P.O. Box 1237
Lynnwood, WA. 98046
or call: (206) 775-6245

Your inquiry will be promptly responded to; we're glad to help. You might be directed to a Carver Professional Products Service Center, or be asked to return the unit to the factory. We must have the serial number of your PM-1.5 before its return can be authorized. When shipped to a service center or the factory, make sure it's in the original carton, well sealed. If convenient, your Carver Professional Products Dealer should be consulted and might be able to offer additional assistance.